

360° EMITTING SILICONE LED FLEX NEON

Model: SE288JC3-025



Features

- 1) Unique optical light distribution structure design, 360° emitting uniform without shadow.
- 2) With integrated extrusion molding process, high light transmittance, environment–friendly silicone material.
- 3) Excellent toughness, stylish appearance, elegant design.
- 4) IP65 protection level, Salt resistance, acid & alkali corrosion resistance, UV and fire resistance.
- 5) Environmentally friendly silicone material, good flexibility with simple appearance.
- 6) ERP spectroscopic standard, single bin supply, good color consistency.
- 7) 3 years warranty.

Application

Home decorative lighting, landscape lighting, city lighting, the places that need linear lighting effect etc.

Parameters

Part Number	SE288JC3–025	CRI	Color	CCT(K)	Beaming Angle	Luminous Flux (LM/M)	Efficacy (LM/W)
Dimensions	5000*25*25mm		WW	● 2700	≥ 320°	700	70
LED Type	/		WW	● 3000	≥ 320°	700	70
LED Qty/m	288LEDs/m	80+	NW	● 4000	≥ 320°	750	75
Voltage	DC24V		MW	● 5000	≥ 320°	700	70
Input Current (A)	0.42A (1m)		W	● 6500	≥ 320°	700	75
Power	10W/M	/	RGB		≥ 320°	150	15
Power Range	9–11W						
Times of Power On and Off	>10000 Times						
IP Grade	IP65						

Remarks:

- 1) The given data are typical values due to the tolerance of the production and electrical components, output value and electrical power can vary up to 10%.
- 2) Testing standards refer to IES LM–79–08.
- 3) The above luminous flux is based on CRI80, and the number will reduce by around 20% in CRI 90.

Dimension

Unit: mm/inch

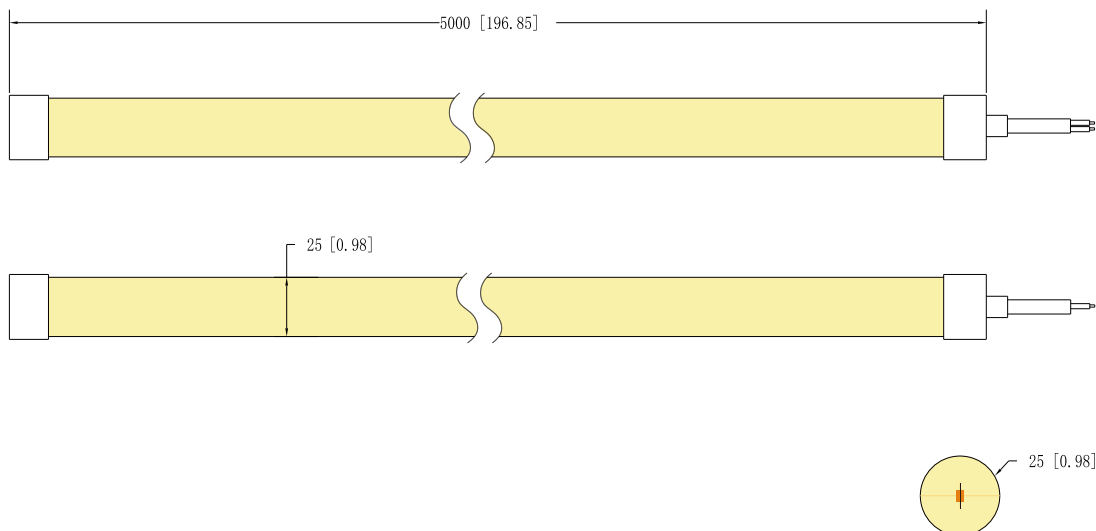

Rendering Index Comparison

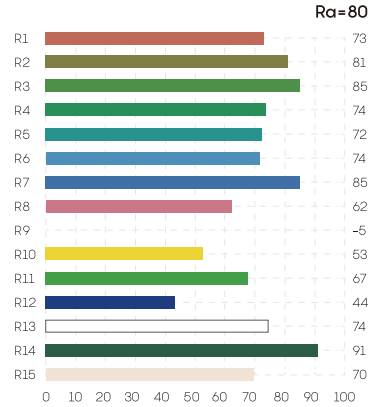
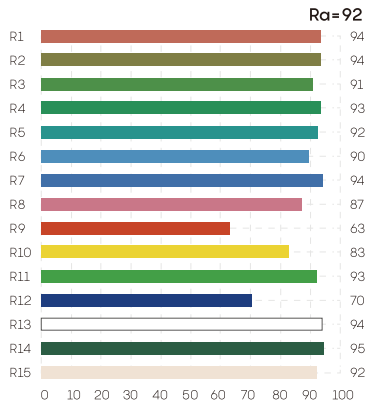

Provide Full CCT Range From 2700K to 6500K

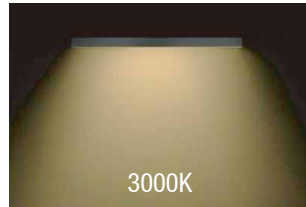

Beaming Angle

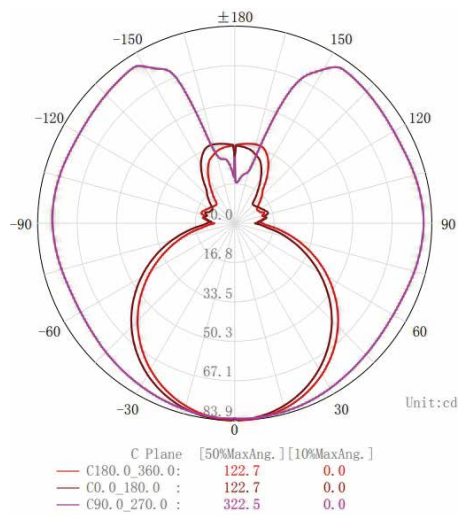

Mounting Accessories

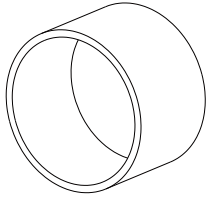

Tail Plug

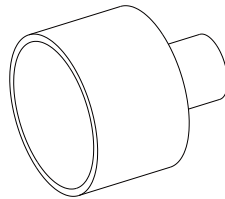

Straight out line Plug

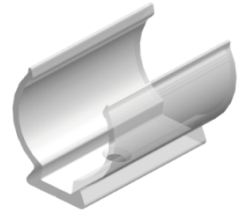

Fixed Buckle

Installation Method

This product 360 ° light, PCB board shear position is invisible, do not recommend customers to shear operation installation.

Snap Installation



Prepare screws and Fixed buckle

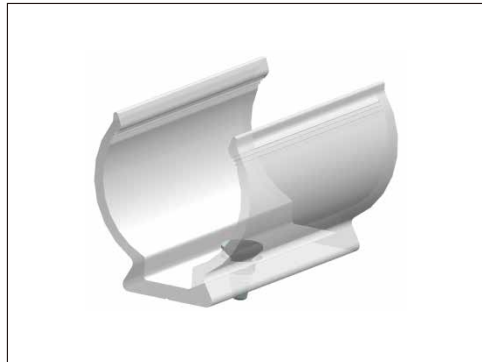

Adjust the Fixed buckle to the right position, the Use a screwdriver to drive in the screws to secure.

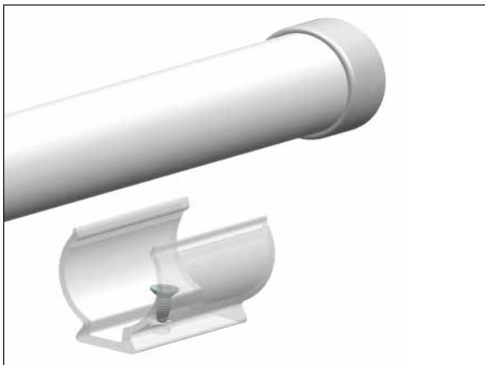

Gently press Set the light bar into the Fixed buckle.

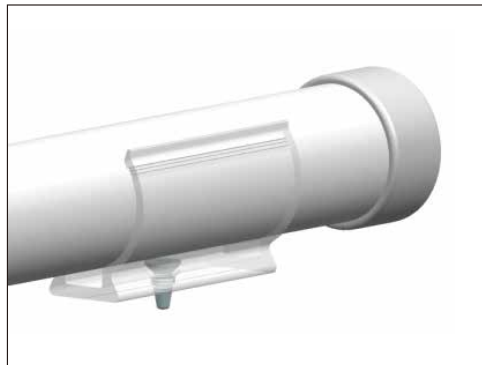

Installation is complete.

Wire Connection

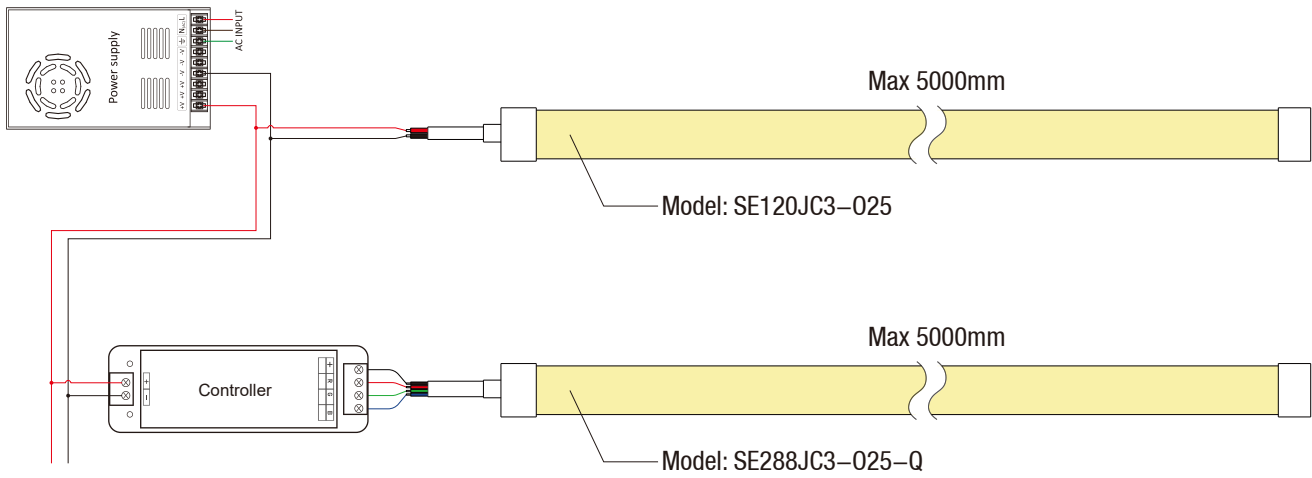

Packing Information

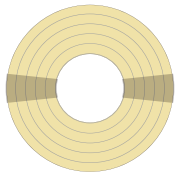

5 meters per roll

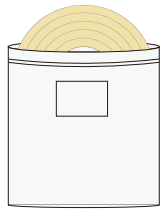

One roll per antistatic bag

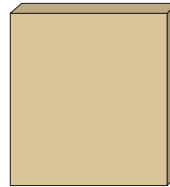

1 Bag per inner box

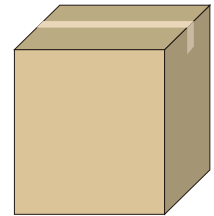

5 Box per carton

Part Number	Outer Box Dimension (mm)	Inner Box Dimension (mm)	Quantity Per Carton (m)	Net Weight (kg)	Gross Weight (kg)
SE288JC3-025	L550*W550*H260	L535*W535*H33	25	14.5	17.2

Given the packing manner difference, the actual packing information is subject to that for the real products.

Bending Direction

Please note when installing the strip, not all directions can be bent, bending shape, bending diameter size and direction, please follow the legend below to avoid damage to the LED strip.

Correct Bend

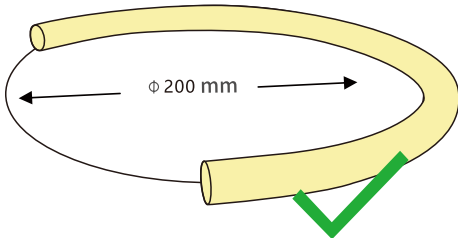

Minimum diameter of 200mm

- This product adopts low-voltage DC power supply and must be used with AC-DC switching power supply after voltage conversion. It is strictly forbidden to connect the LED strip directly to AC110V or AC220V utility voltage, otherwise it will damage the LED strip and may cause safety accidents.
- Please read the product specification carefully before using this product, and also ask the professional to install it to ensure safe use.

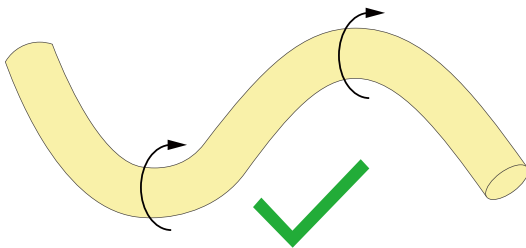

Bending diameter must be greater than 200mm

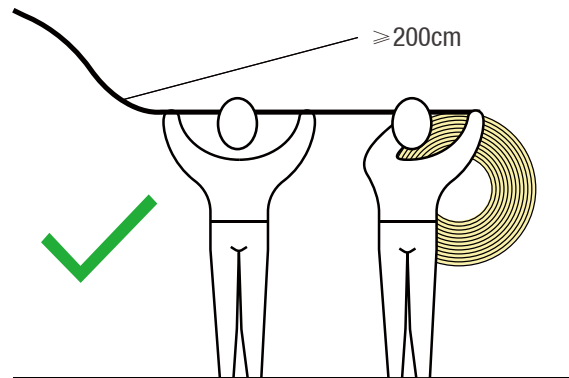

When the length of the strip is longer than 2 meters, have two people work together to install it.

Wrong Bend

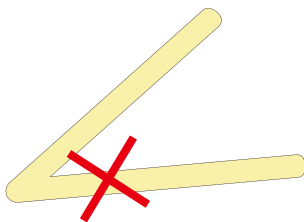

Small Angle bending is prohibited.

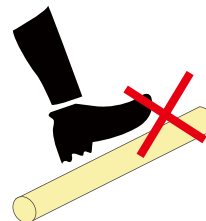

Prohibit trample

Instructions

- 01) Disassembling or modifying the product is not allowed.
- 02) Installation with power on is not allowed.
- 03) Any organic solvent chemical is not allowed.
- 04) Isolation and corrosion prevention on all wiring points and wire ends.
- 05) Make sure the power wire is big enough and ensure the voltage and connection are all correct before power on.
- 06) Installation, maintenance should be done by professional staff.
- 07) The power wire between power supply and LED strips should be less than two meters to keep the same brightness on all parts.
- 08) Do not power on during installation or assembly of the light strip, to avoid short-circuiting and burning out of the light strip due to misoperation during the operation
- 09) The lamp beads can only be powered on when they are connected, installed and correct.
- 10) When installing, try to avoid excessive bending and twisting of the light strip, so as not to damage the conductive components and cause defects.
- 11) The LED flexible light strip can only be cut at the place where the cut mark is printed on the light strip. Cutting at other places will damage the circuit circuit of the light strip and cause some lamp beads to not light up.
- 12) The minimum bending diameter of this product: 200mm.

Declaration

- 01) To ensure the safety, the broken wires need to be replaced by the manufacturer or the service agent, or by the qualified staff.
- 02) The given data in the specification is the laboratory data, there may be discrepancy found in the actual products.
- 03) The given drawings in the specification are only for reference, there may be discrepancy found in the actual products.
- 04) The products are subject to change without prior notification.



Official Website



WeChat Public

SHENZHEN LEADBEYOND LINEAR LIGHTING CO., LTD.

Tel: +86-755-83056231 info@leadbeyondled.com www.leadbeyondled.net www.leadbeyondled.com

Company Address.: 28F, Luban Building, Hongli West Road, Futian District, Shenzhen 518034, China

Factory Address: 3F, 4F and 6F, Buiding A&B Xinyongfeng Industrial Area, Yingrenshi Village, Shiyan Town, Bao'an District, Shenzhen 518108, China