

# SILICONE LED FLEX NEON

Model: SE120JC3-D1225

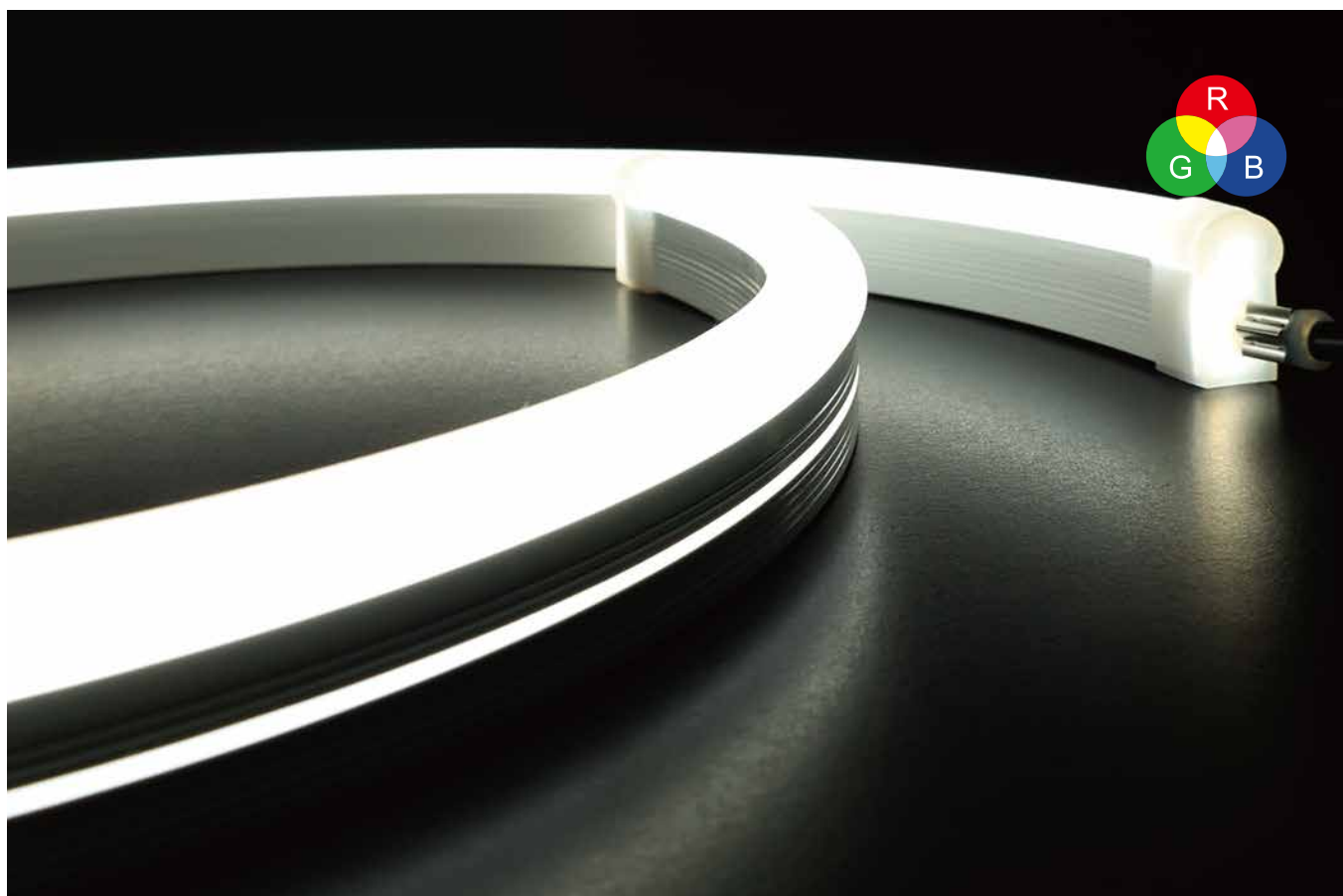

## Features

- 1) Unique optical distribution design, side emitting light source.
- 2) Light-emitting angle 120°, light emits evenly with high brightness.
- 3) Environmentally friendly silicone material, good flexibility with simple appearance.
- 4) IP65 protection level, acid, alkali, salt corrosion resistance, UV resistance.
- 5) ERP spectroscopic standard, single bin supply, good color consistency.
- 6) 3 years warranty.

## Application

Home decorative lighting, landscape lighting, city lighting, the places that need linear lighting effect etc.

## Parameters

Part Number	SE120JC3-D1225	CRI	Color	CCT(K)	Wavelength (nm)	Luminous Flux (LM/M)	Efficacy (LM/W)
Dimensions	5000*12*25mm	80+	WW	2700	/	365	38
LED Qty/m	120LEDs/m		WW	3000	/	393	41
Voltage	DC24V		NW	4000	/	413	43
Input Current (A)	0.4A (1m)		MW	5000	/	403	42
Power	9.6W/M		W	6500	/	393	41
Power Range	8.6~10.5W						
Times of Power On and Off	>10000 Times						
IP Grade	IP65						

## Remarks:

- 1) The given data are typical values due to the tolerance of the production and electrical components, output value and electrical power can vary up to 10%.
- 2) Testing standards refer to IES LM-79-08.
- 3) The above luminous flux is based on CRI80, and the number will reduce by around 20% in CRI 90.

## Dimension

Unit: mm/inch

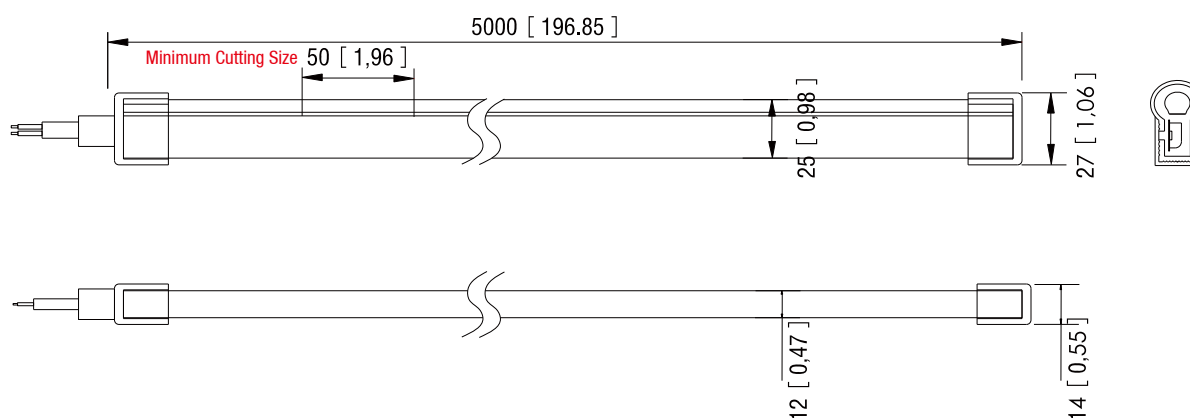

## Rendering Index Comparison

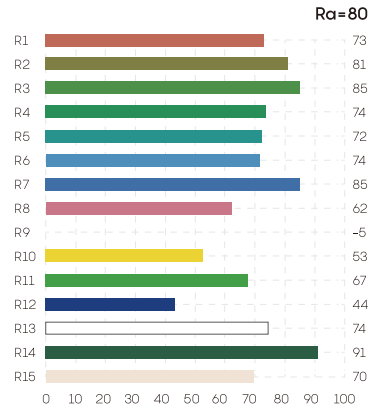
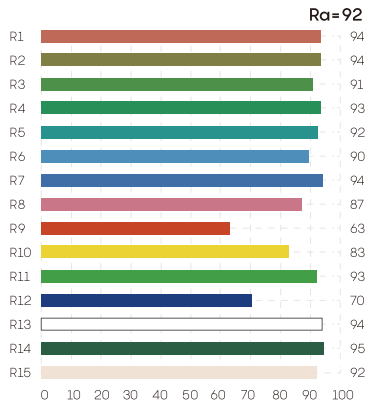

## Provide Full CCT Range From 2700K to 6500K

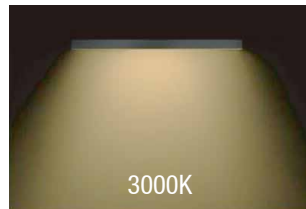
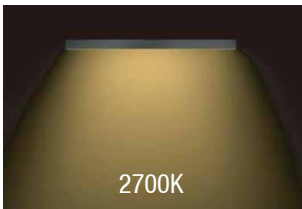

## Beaming Angle

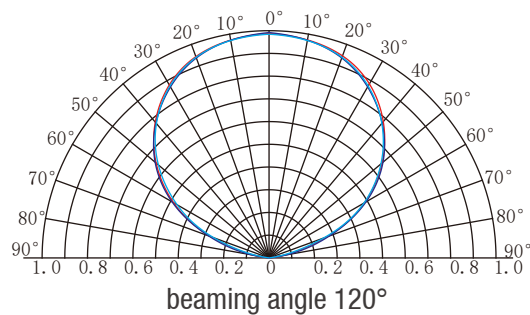

## Coordinates and Tolerances Conform to CIE 1931

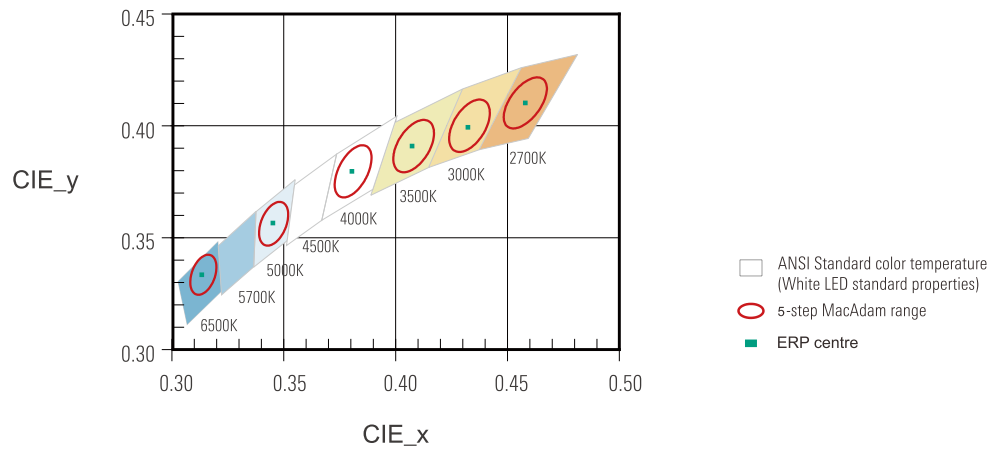

	2700K	3000K	3500K	4000K	5000K	6500K
x0	0.463	0.433	0.408	0.380	0.346	0.313
y0	0.420	0.403	0.393	0.380	0.359	0.337

## Wire Connection

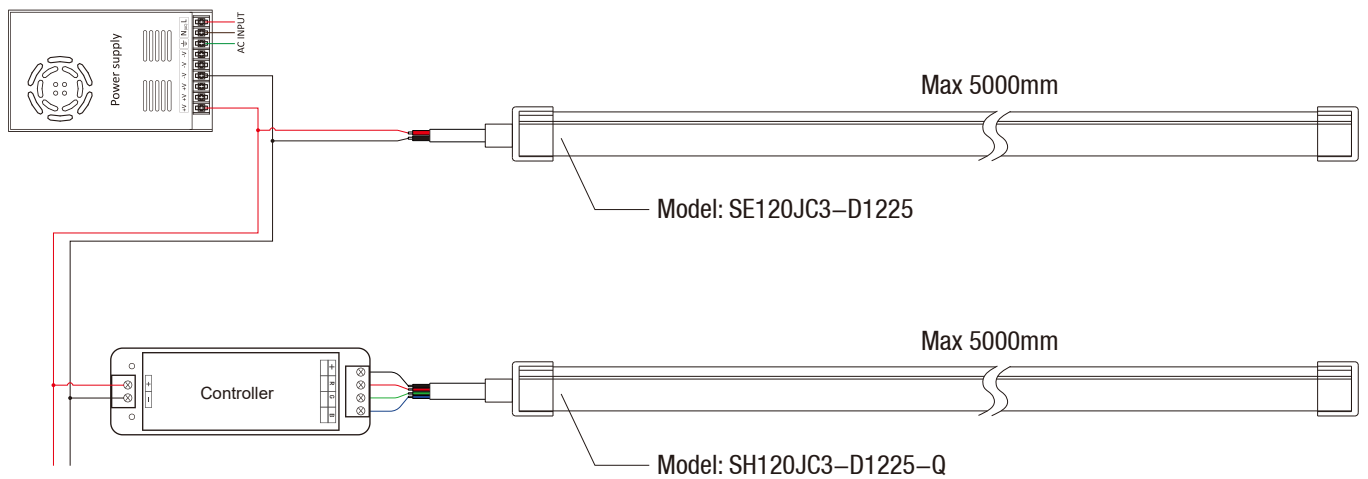

## Mounting Accessories

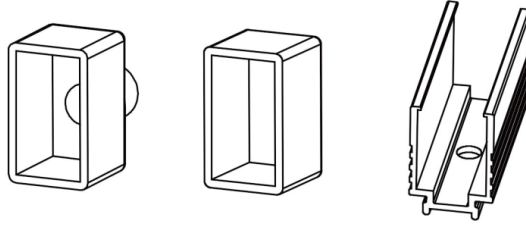

Straight out line Plug

Tail Plug

Fixed Buckle

## Packing information

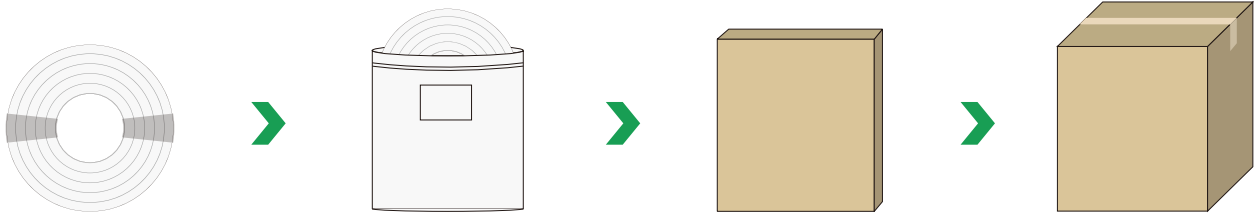

5 meters per roll

One roll per antistatic bag

1 Bag per inner box

10 Box per carton

Part Number	Outer Box Dimension (mm)	Inner Box Dimension (mm)	Quantity Per Carton (m)	Net Weight (kg)	Gross Weight (kg)
SE120JC3-D1225	L428*W330*H420	L410*W400*H30	50	15.4	19

Given the packing manner difference, the actual packing information is subject to that for the real products.

## Bending Direction

Please note when installing the strip, not all directions can be bent, bending shape, bending diameter size and direction, please follow the legend below to avoid damage to the LED strip.

### Correct Way to Bend

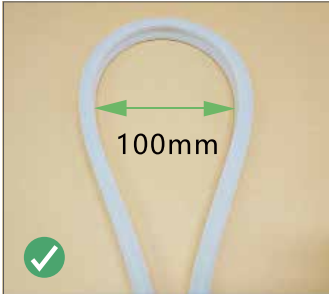

### Wrong Way to Bend

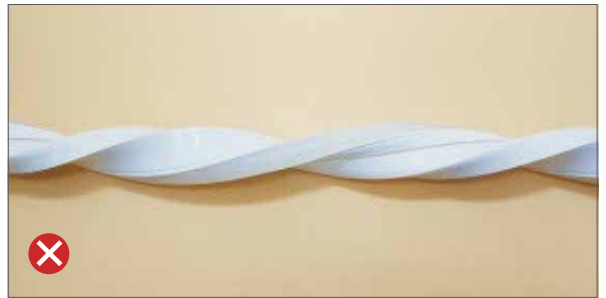
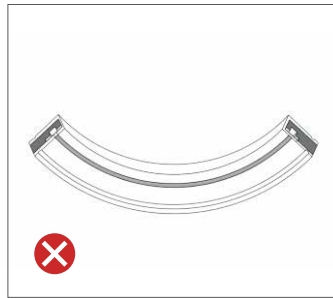

## Installation Method

### Shear Mounting

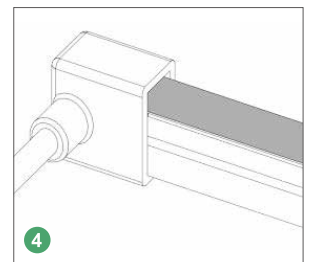
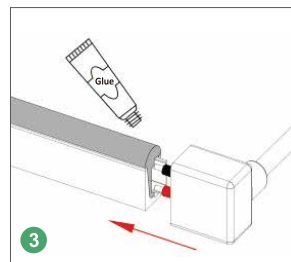
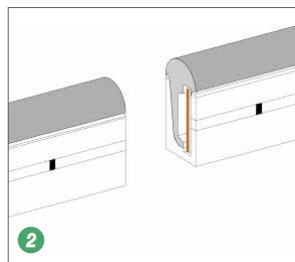
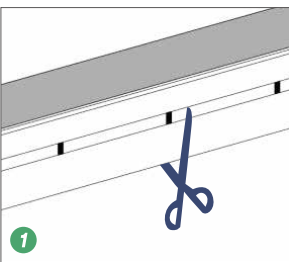

### Accessories installation

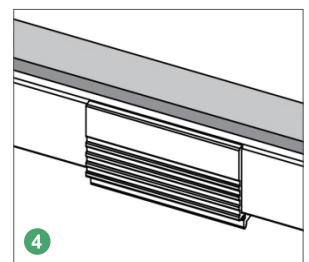
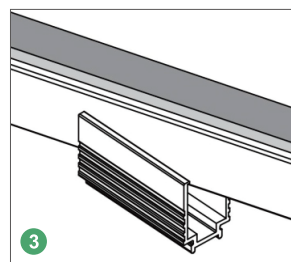
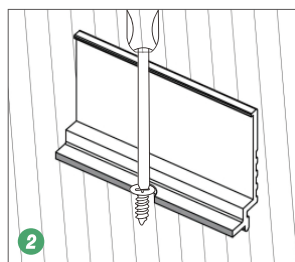
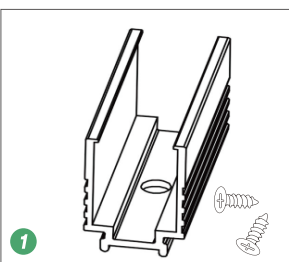

## Instructions

- 01) Disassembling or modifying the product is not allowed.
- 02) Installation with power on is not allowed.
- 03) Any organic solvent chemical is not allowed.
- 04) Isolation and corrosion prevention on all wiring points and wire ends.
- 05) Make sure the power wire is big enough and ensure the voltage and connection are all correct before power on.
- 06) Installation, maintenance should be done by professional staff.
- 07) The power wire between power supply and LED strips should be less than two meters to keep the same brightness on all parts.
- 08) Do not power on during installation or assembly of the light strip, to avoid short-circuiting and burning out of the light strip due to misoperation during the operation
- 09) The lamp beads can only be powered on when they are connected, installed and correct.
- 10) When installing, try to avoid excessive bending and twisting of the light strip, so as not to damage the conductive components and cause defects.
- 11) The LED flexible light strip can only be cut at the place where the cut mark is printed on the light strip. Cutting at other places will damage the circuit circuit of the light strip and cause some lamp beads to not light up.
- 12) The maximum bending diameter of this product: >100mm.

## Declaration

- 01) To ensure the safety, the broken wires need to be replaced by the manufacturer or the service agent, or by the qualified staff.
- 02) The given data in the specification is the laboratory data, there may be discrepancy found in the actual products.
- 03) The given drawings in the specification are only for reference, there may be discrepancy found in the actual products.
- 04) The products are subject to change without prior notification.



Official Website



WeChat Public

## SHENZHEN LEADBEYOND LINEAR LIGHTING CO., LTD.

Tel: +86-755-83056231    info@leadbeyondled.com    www.leadbeyondled.net    www.leadbeyondled.com

Company Address.: 28F, Luban Building, Hongli West Road, Futian District, Shenzhen 518034, China

Factory Address: 3F, 4F and 6F, Buiding A&B Xinyongfeng Industrial Area, Yingrenshi Village, Shiyan Town, Bao'an District, Shenzhen 518108, China